

TECHLUME

A U S T R A L I A

LM-79 Test Report

Testing Method:	IES Approved Method: Electrical and Photometric Measurements of Solid-State Lighting Products
Relevant Standards:	IES LM-79-08
Test Date and Time:	18/10/2023 11:53:23 AM
Test Location:	Techlume Australia - East Goderich Street Deloraine, TAS 7304
Operator:	Johnny Elmer
Measurement Number:	VFR-231018-0228-MS
Measurement Method:	Far Field, Type C Horizontal
Measurement Distance:	450.7 cm

Equipment Used

System Name:	LabSpion Goniometer
Sensor Name / Model:	Viso LabSensor Model2 / Freedom VIS (Custom Viso)
Spectrometer Range:	360 nm – 830 nm
Calibration Date:	7/12/2022
Flicker Meter Type:	Viso Systems LabFlicker
Manufacturer:	Viso Systems, Denmark

Test Conditions

Ambient Temperature:	25 °C ± 1 °C
----------------------	--------------

Remarks

The results stated in this report represent the tested sample only. All photometric and colourimetric data has been measured in compliance with IES LM-79-08 standards.



Product Overview

Product Description: KARGO 13W Downlight, 90mm Cutout, White Trim, Tri-colour, IP54, Phase Dim

Item Number: LC3615 (4000K)

Manufacturer: Decrolux Lighting Pty Ltd

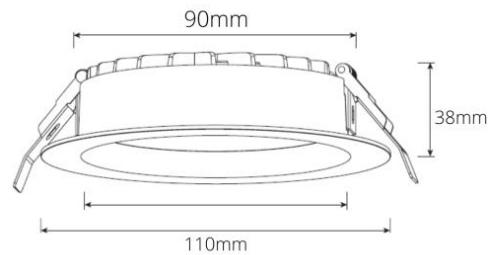

Photometric Measurements

Total Luminous Flux	Luminous Efficacy	Luminous Intensity
1362 lm	114 Lumen/watt	601 cd

Correlated Colour Temperature, Target	Correlated Colour Temperature, Measured	Colour Rendering Index (CRI)
4000 K	3957 K	Ra 85.3

Electrical Measurements

Input Voltage	Input Current	Input Power	Input Voltage Frequency
240 VAC	0.052 A	11.9 W	60 Hz

Power Factor	Stabilisation Time	Stabilisation Variation	Hours Operated Prior to Test
0.95	Lamp stabilized in 30 min 3 sec	-1.0%	0 hours



Spectral Power Distribution (SPD)

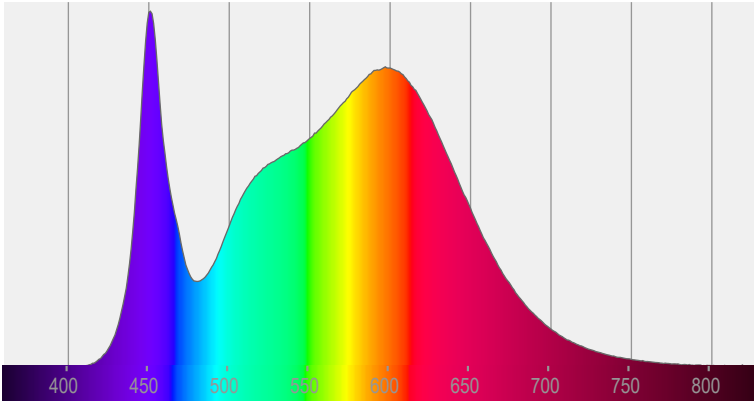

Input Power Curve

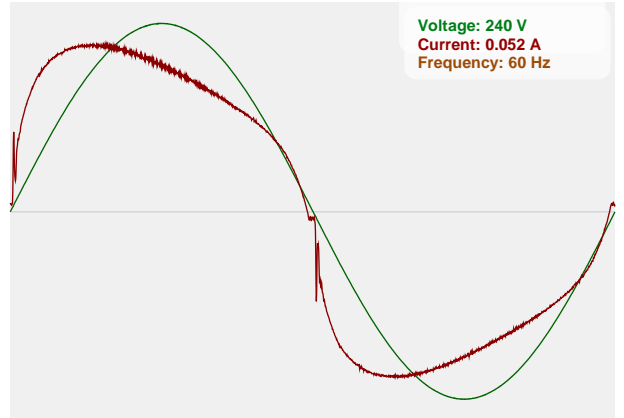

Flicker Details

Flicker Sample Rate	Flicker Percentage	Flicker Frequency	Flicker Index
20000 sample/s	0.79%	119.76 Hz	0

Flicker SVM Value	Flicker PstLM Value	Measurement Time (PstLM)	Measurement Time (all other indices)
0.03	0.05	180 s	1.2 s

IEEE 1789 Frequency/Modulation Plot

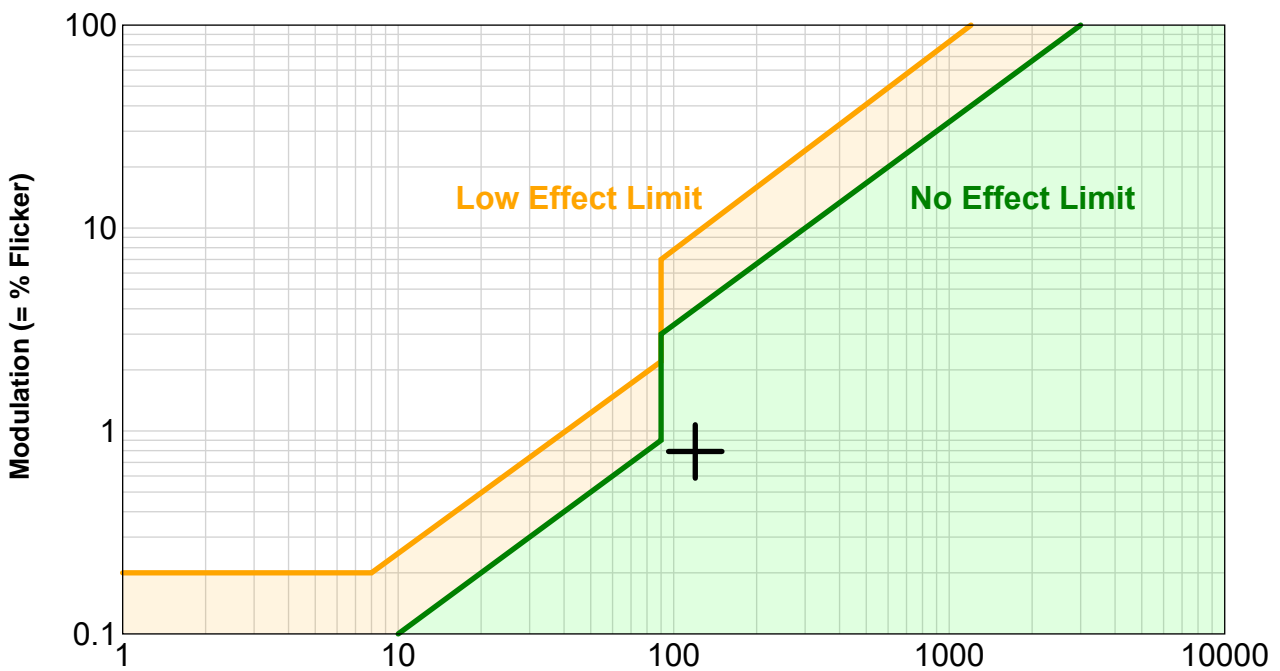

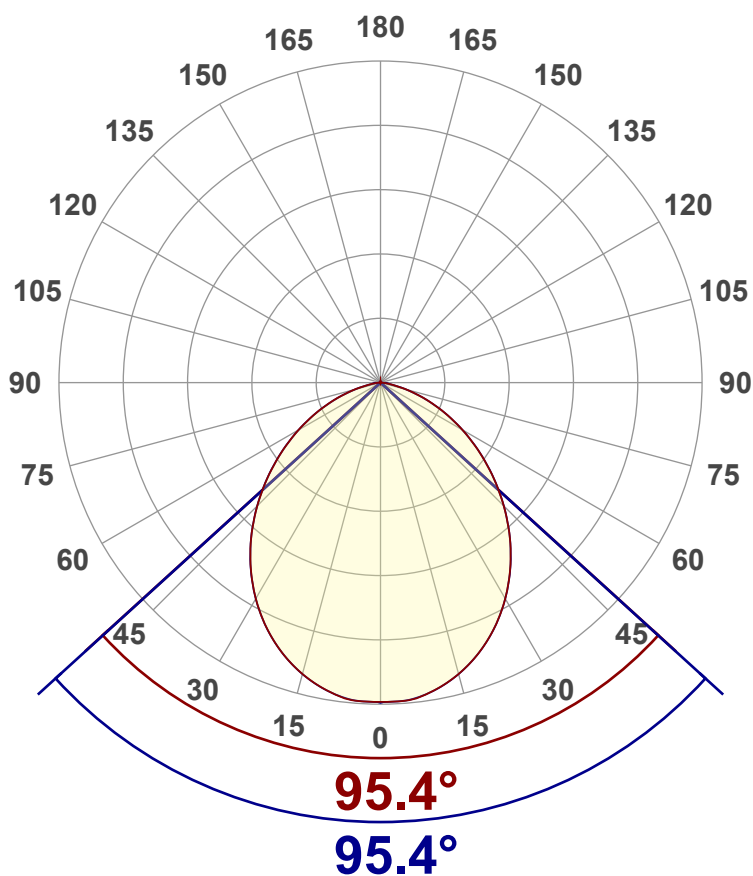
Angular Distribution – 0° / 90° Plane

Main Values

Total Lumen Output	1362 lm
Lumen Up%	0.18%
Lumen Down%	99.82%
Peak Intensity	601 cd
Beam Angle (90%)	95.4°

Cut-off Angle

Average 2.5%	164°
---------------------	------

Field Angle

Average 10%	147.2°
--------------------	--------

Intensity Ratio

In 120° Cone	85.6%
In 90° Cone	61.8%

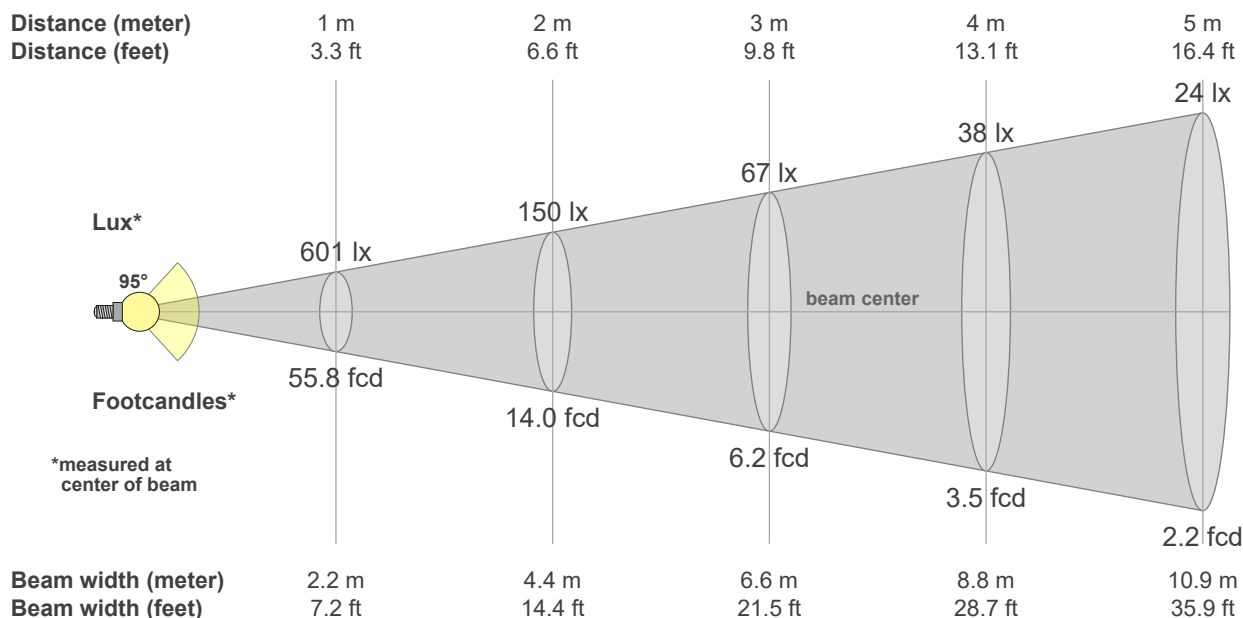
C000-C180
C090-C270

Beam intensities from 1 – 20m

1	2	3	4	5	6	7	8	9	10	11	12	13	14	15	16	17	18	19	20	m
3.3	6.6	9.8	13.1	16.4	19.7	23	26.2	29.5	32.8	36.1	39.4	42.7	45.9	49.2	52.5	55.8	59.1	62.3	65.6	ft
601	150	67	38	24	17	12	9	7	6	5	4	4	3	3	2	2	2	2	2	lux
55.8	14	6.2	3.5	2.2	1.6	1.1	0.9	0.7	0.6	0.5	0.4	0.3	0.3	0.2	0.2	0.2	0.2	0.2	0.1	fc



Colour Details

Colour Rendering Index (CRI)	Colour Rendering Index R9 Value	Colour Rendering TM30-18
Ra 85.3	R9 = 17.9	R _f 85.0, R _g 96.7

Colour Quality Scale	Correlated Colour Temperature, Target	Correlated Colour Temperature, Measured
CQS = 83.5	CCT = 4000 K	CCT = 3957 K

MacAdam Steps	Colour Coordinates CIE 1931	Colour Deviation from BBL
SDCM = 1.8	(x;y) = (0.381;0.377)	Duv = -0.0022

Colour Rendering Index per reference colour (CIE 1995)

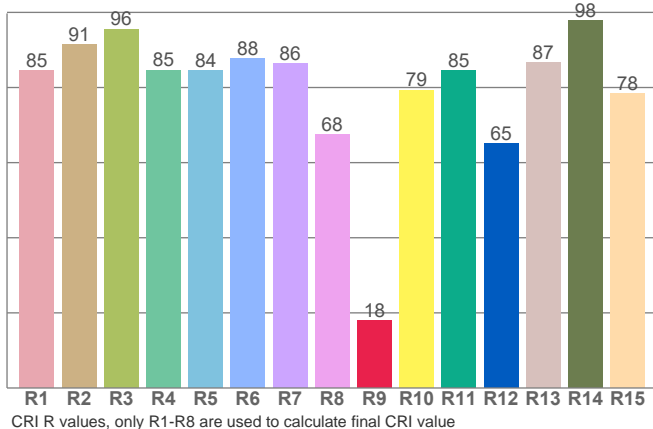

R1	R2	R3	R4	R5	R6	R7	R8	R9	R10	R11	R12	R13	R14	R15
84.5	91.5	95.5	84.7	84.5	87.6	86.3	67.5	17.9	79.3	84.5	65.0	86.6	97.8	78.4

TM30-18 R_f-values per hue bin

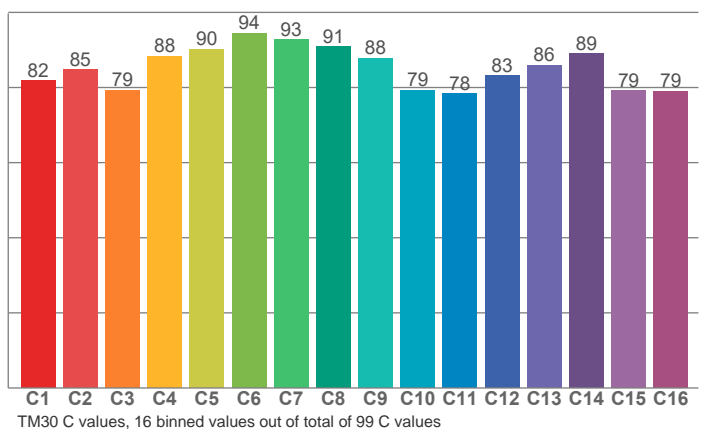

C1	C2	C3	C4	C5	C6	C7	C8	C9	C10	C11	C12	C13	C14	C15	C16
81.8	84.7	79.3	88.4	90.2	94.4	92.8	90.9	87.8	79.3	78.4	83.2	85.9	89.0	79.2	79.0

CIE 1931

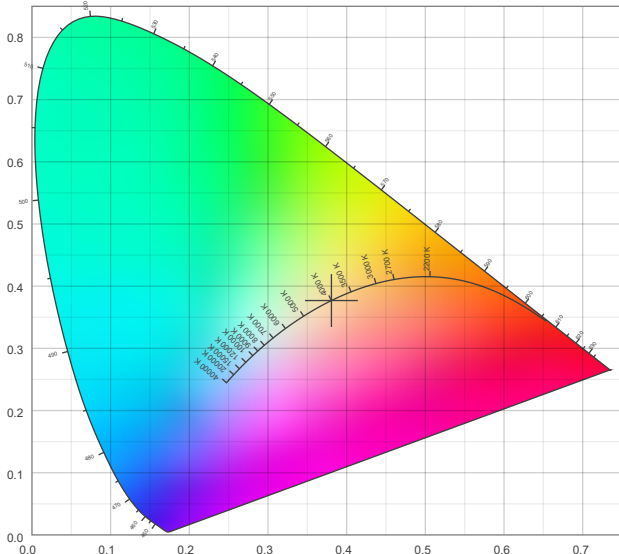

CIE 1931 – Zoomed

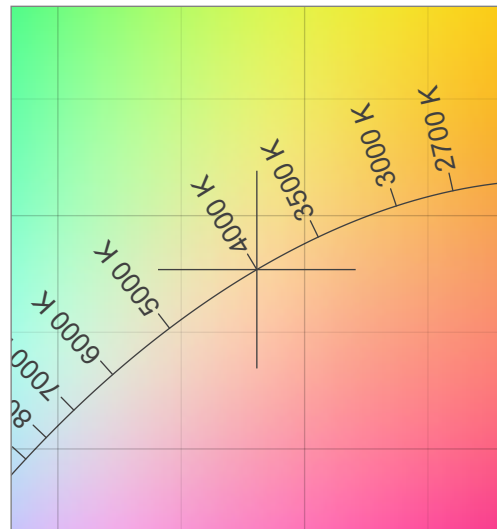

Iso-intensity Diagram (Iso-Candela)

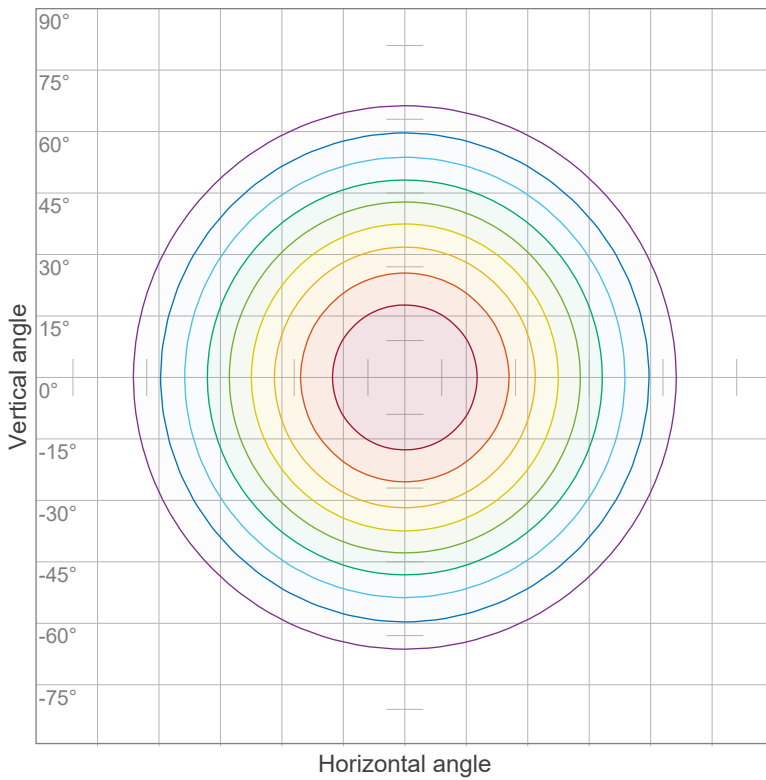

90 %	540.8 cd
80 %	480.7 cd
70 %	420.6 cd
60 %	360.5 cd
50 %	300.4 cd
40 %	240.4 cd
30 %	180.3 cd
20 %	120.2 cd
10 %	60.1 cd

Peak intensity: 600.9 cd
Number of c-planes: 24

Iso-illuminance Diagram (Iso-lux)

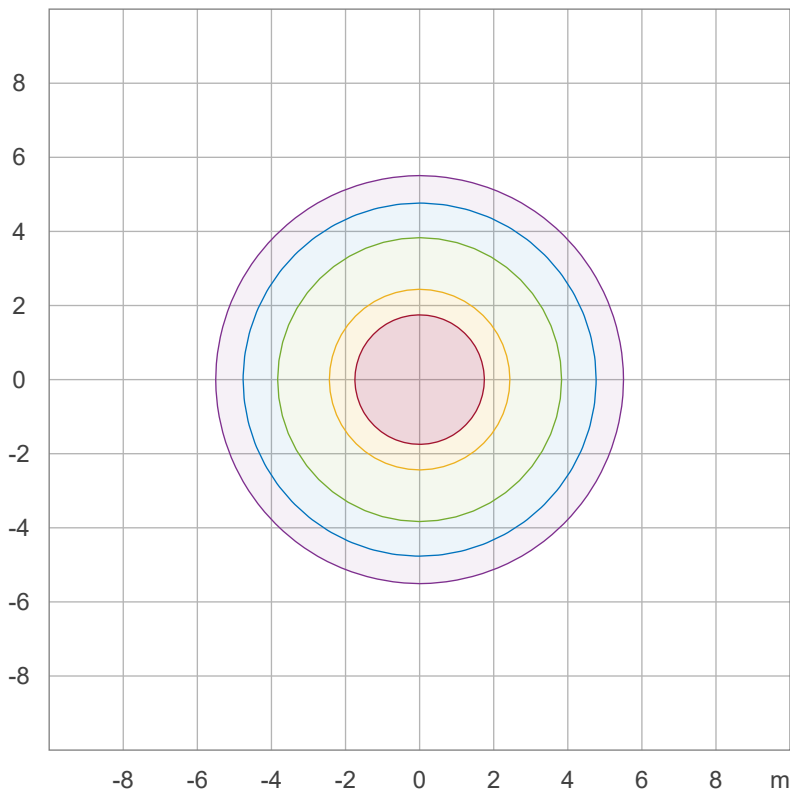

50.0 %	33.4 lx
30.0 %	20.0 lx
10.0 %	6.7 lx
5.0 %	3.3 lx
3.0 %	2.0 lx

Peak illuminance: 66.8 lx
Mounting height: 3.0 m
Number of c-planes: 24



Light Planning – UGR table

Uncorrected, comprehensive UGR table according to 117-1995

Reflectances		70	70	50	50	30	70	70	50	50	30
ρ Ceiling		70	70	50	50	30	70	70	50	50	30
ρ Walls		50	30	50	30	30	50	30	50	30	30
ρ Floor		20	20	20	20	20	20	20	20	20	20
Room size		Viewed Crosswise					Viewed Endwise				
H = mounting height above eye level		(Viewing direction orthogonal to lamp length axis)					(Viewing direction parallel to lamp length axis)				
X	Y										
2H	2H	25.7	26.8	25.9	27.1	27.3	25.6	26.8	25.9	27.1	27.3
	3H	26.4	27.5	26.8	27.8	28.0	26.4	27.5	26.8	27.8	28.0
	4H	26.6	27.7	27.0	27.9	28.2	26.6	27.7	27.0	27.9	28.2
	6H	26.7	27.7	27.0	27.9	28.3	26.7	27.6	27.0	27.9	28.3
	8H	26.7	27.6	27.0	27.9	28.3	26.6	27.6	27.0	27.9	28.3
	12H	26.6	27.5	27.0	27.9	28.3	26.6	27.5	27.0	27.8	28.3
4H	2H	26.0	27.1	26.4	27.4	27.6	26.0	27.1	26.4	27.4	27.6
	3H	27.0	27.9	27.4	28.2	28.7	27.0	27.9	27.3	28.2	28.7
	4H	27.2	28.0	27.6	28.4	29.0	27.2	28.0	27.6	28.4	28.9
	6H	27.3	28.1	27.8	28.4	28.8	27.2	28.0	27.7	28.4	28.8
	8H	27.3	28.0	27.8	28.4	28.7	27.2	28.0	27.7	28.3	28.7
	12H	27.2	27.8	27.7	28.3	28.7	27.2	27.8	27.7	28.2	28.7
8H	4H	27.2	28.0	27.7	28.3	28.7	27.2	27.9	27.7	28.3	28.7
	6H	27.4	27.9	27.9	28.4	28.9	27.3	27.9	27.9	28.4	28.9
	8H	27.4	27.9	27.9	28.4	29.0	27.4	27.8	27.9	28.4	29.0
	12H	27.4	27.8	28.0	28.3	28.9	27.4	27.8	28.0	28.3	28.9
12H	4H	27.2	27.8	27.7	28.2	28.7	27.2	27.8	27.7	28.2	28.7
	6H	27.4	27.8	27.9	28.4	29.0	27.4	27.8	27.9	28.3	29.0
	8H	27.4	27.8	28.0	28.3	28.9	27.4	27.8	28.0	28.3	28.9
Variations with the observer position for the luminaire spacings, S:											
S = 1.0H		0.2 / -0.3					0.2 / -0.3				
S = 1.5H		0.5 / -0.9					0.5 / -0.9				
S = 2.0H		1.2 / -1.8					1.2 / -1.8				

Coefficients of Utilization

Ceiling reflectance	80			70			50			30			10			0		
Wall reflectance	70	50	30	10	70	50	30	10	50	30	10	50	30	10	50	30	10	0
Floor reflectance	20	20	20	20	20	20	20	20	20	20	20	20	20	20	20	20	20	0
RCR		(RCR: Room Cavity Ratio)																
Room Values are expressed as percentage of Lumen delivered to the task surface																		
0	119	119	119	119	116	116	116	116	111	111	111	106	106	106	102	102	102	100
1	110	106	102	99	107	104	100	97	99	97	94	95	93	91	92	90	88	86
2	101	94	87	82	98	92	86	81	88	83	79	85	81	78	82	79	76	74
3	93	83	76	70	90	82	75	69	79	73	68	76	71	67	73	69	65	63
4	85	74	66	60	83	73	65	59	70	64	59	68	62	58	66	61	57	55
5	79	67	58	52	77	66	58	52	64	57	51	62	56	51	60	54	50	48
6	73	60	52	46	71	60	52	46	58	51	45	56	50	45	55	49	45	43
7	68	55	47	41	66	54	46	41	53	46	40	51	45	40	50	44	40	38
8	63	50	42	37	62	50	42	37	48	41	36	47	41	36	46	40	36	34
9	59	46	39	33	58	46	38	33	45	38	33	44	37	33	43	37	33	31
10	56	43	35	30	54	42	35	30	41	35	30	41	34	30	40	34	30	28

NOTE: An asymmetry correction has been applied to the beam distribution of this measurement in order to accurately calculate UGR.

